

BW06K

6KW Laser Welding Head - User Manual

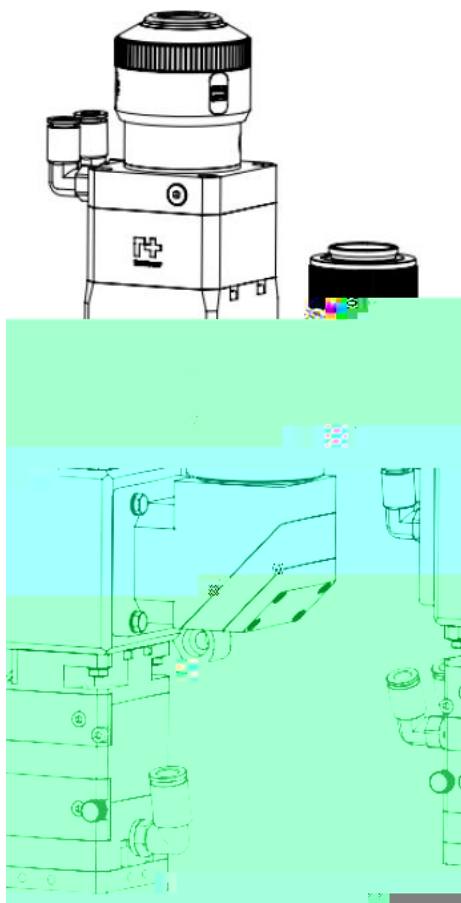

Document History

Edit date	Version	Topic, revision, action taken
2025/7/1	V1.0	First edition

Thank you for choosing our product!

This manual describes the installation and commissioning of laser welding head in details so that you can use this product quickly. You can consult us directly for more details.

Due to the continuous updating of product functions, the product you receive may differ from the introduction in this manual in some aspects.

We reserve all rights in this document including the issued patents and other registered commercial ownership related to this document. It is strictly prohibited to use this document in an improper way especially to copy and disseminate it to third parties.

If you find any errors in this document, please inform us as soon as possible. The data contained in this manual is only used to describe the product and shall not be regarded as a statement of security interest.

For the benefit of our customers, we will constantly try to ensure that the products we develop comply with the latest technology.

Raytools AG

Email: sales@raytools.com

Website: www.raytools.ch

Disclaimer

We reserve the right to change the design in order to improve the quality or expand the application or comply to manufacturing workmanship.

We will not bear any responsibility for losses and accidents caused by wrong operation or improper handling of our products.

Dismantling of product will lose all warranty claims excluding the normal replacement of worn parts and components required for maintenance or commissioning operations.

Unauthorized modification of products or use of non-original spare parts will directly lead to the invalidation of warranty and liability exemption.

It is recommended to only use the spare parts provided by us or submit them to us or the designated professional team for installation.

Use Regulations

Ensure that the product is used in a dry environment.

Ensure that the product is used in the environment required by EMC standards.

The product is only allowed to run within the parameters specified in the technical data.

Personnel Responsibilities

Be familiar with the basic provisions of work safety & accident prevention and have received equipment operation guidance.

Read and understand basic safety instructions and operations.

You must have studied the relevant regulations and safety instructions and understand the possible hazards.

Comply with relevant regulations and implement corresponding protective measures.

Safety Instructions

Prevent Electric Shock



Parts of the laser head such as nozzle, sensor, sensor interface and attached fasteners may not be fully protected by the ground wire due to function fault. These parts may have low voltage. When installing electrical equipment, please pay attention to taking anti electric shock measures for relevant personnel.



Note that the equipment shall be grounded as specified.

Guard against Danger

Never put your hands or other body under the laser head.

Repair and maintenance work can only be carried out after the power is turned off.

Do not exceed the specified maximum pressure.

It must be ensured that the laser head is in normal condition at all times.

All fasteners such as bolts and nuts must be tightened.



Laser Caution

Avoid direct laser radiation or scattering to the skin.

Do not stare at the laser beam even when wearing optical equipment.

Use special laser protective eyeglasses that meet the requirements of safety standards IEC 60825-1.

Prevent Waterway Corrosion

In order to avoid corrosion, use the specified coolant and comply with relevant requirements and specified maintenance intervals.

Noise Prevention

The corresponding measures shall be specified or explained and observed in order to prevent personnel from being harmed by noise when the cutting air pressure is high.

Storage and Transportation

Observe the storage temperature range allowed by the technical data.

Take reasonable measures to prevent fire, vibration or impact.

Do not store in or near the magnetic field.

Contents

1 Product Summary	1
1.1 Structure (with QBH Interface)	1
1.2 Technical Datasheet	2
1.3 Mechanical Size	3
1.4 Connection of Assist Gas.....	4
1.5 Connection of Cooling Water	5
1.6 Wiring.....	6
1.7 HMI Panel and Camera Interface.....	7
1.8 Field Center	8
2 Mechanical Installation.....	9
2.1 QBH Fiber Insertion.....	11
2.2 Wrap with Protective Film	11
2.3 Mounting of Laser Welding Head	12
2.4 Mounting of Tip Assembly (Optional).....	13
3 Maintenance.....	14
3.1 Removal and Installation of Lenses	14
3.2 Removal and Installation of Top Cover Glass/Protection Glass	14
4 Appendix	16
4.1 Mechanical Size.....	16

1 Product Summary

1.1 Structure (with QBH Interface)

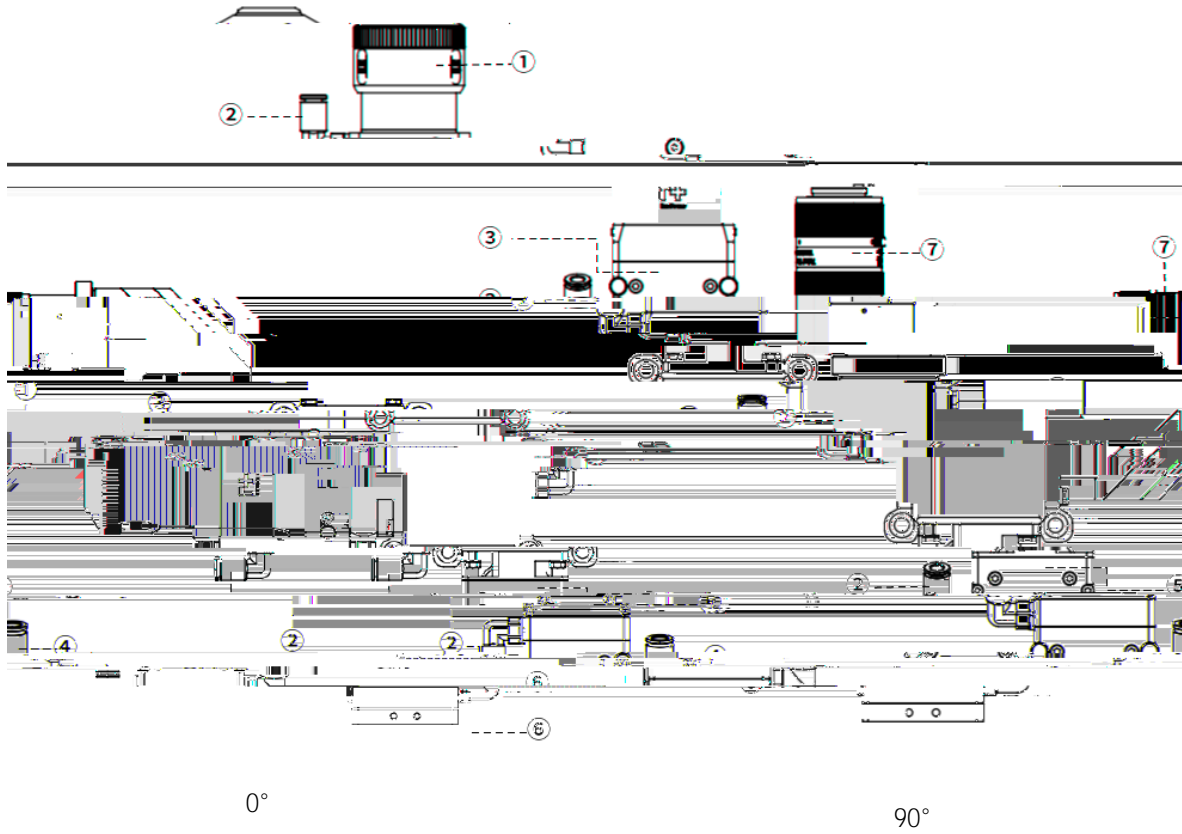

- 1 Fiber Interface
- 2 Water Cooling Interface
- 3 Top Cover Glass Holder
- 4 Assist Gas Interface

7 0 =
 " # 8 =
 ##)

1.2 Technical Datasheet

Model	BW06K
Wavelength	1064nm
Power Rating	6KW
Fiber Interface	QBH (standard) / QD (optional)
Clear Aperture	34mm
Collimation Length (fC)	100mm/125mm/150mm
Focusing Length (fF)	150mm/200mm/250mm/300mm
Cover Glass Specification	D37X5
CCD Module	C/CS interface
Water Cooling	Ø6mm
Assist Gas	Ø8mm
Size	323.3*160mm (F100, 0°)
Weight	~3kg
Extensible Function	temperature detection of lens

1.3 Mechanical Size

Collimation F100 (0°):

(Other specifications refer to appendix)

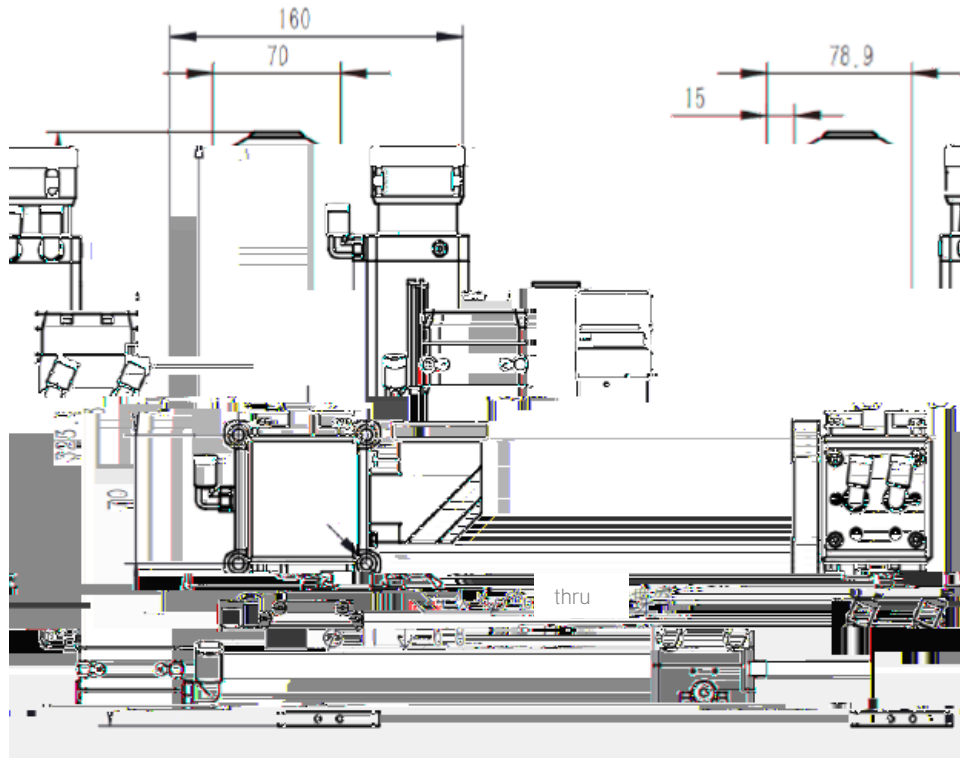

Collimation F100 (90°):

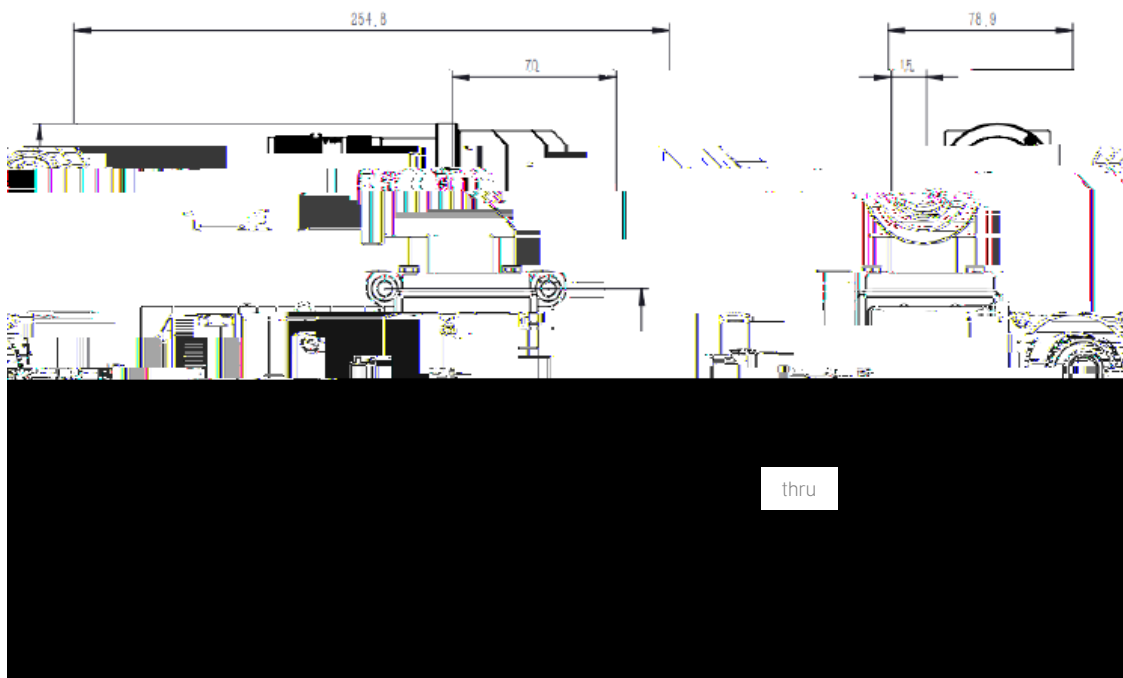

1.4 Connection of Assist Gas

Gas requirements:

Compressed air pressure: 0.4-0.6MPa

Nitrogen/Argon gas flow: 8-25L/min

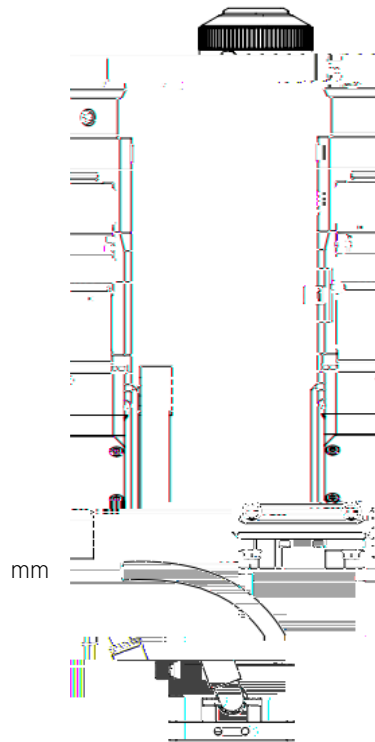

1.5 Connection of Cooling Water

1.7 HMI Panel and Camera Interface

Lens interface:



Camera interface:

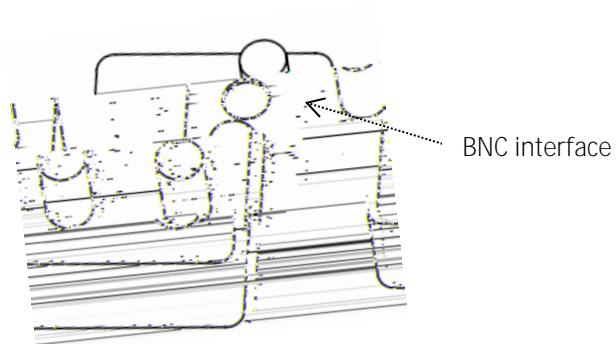

1.8 Field Center

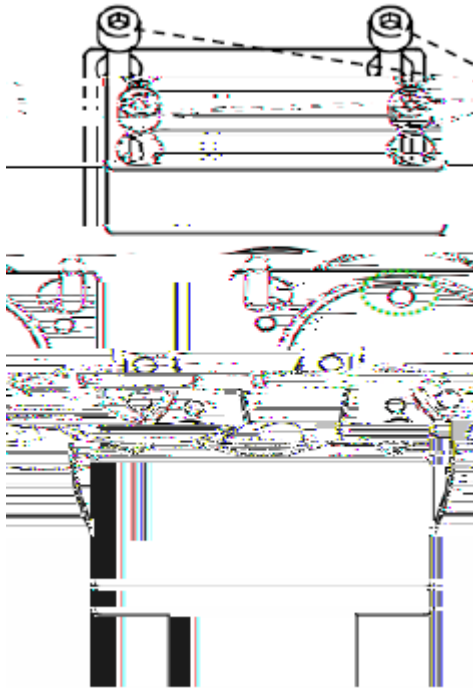
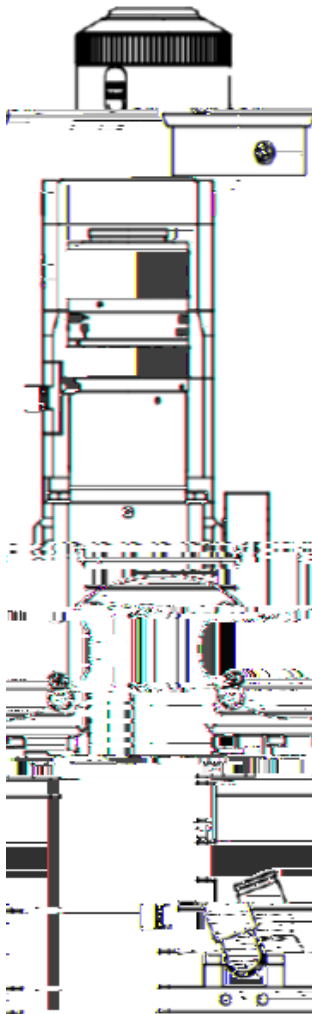

Remove 4 bolts and cover panel

Adjust 3 mechanical positions (red area) to center

Center effect:



2 Mechanical Installation

1. Prepare the clean bench:
Turn on the clean bench.
Clean the surface of the clean bench.
Lower the glass door, leaving a 10 cm gap.
Run the device for 30 minutes

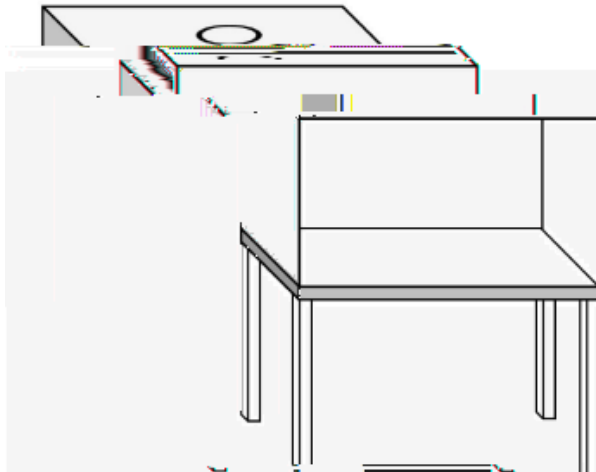

Type: Vertical Laminar Flow
Cleanliness Class: ISO Class 5 / Class 100
Average Air Velocity: 0.4 m/s

2. Place the laser head on the clean bench horizontally.

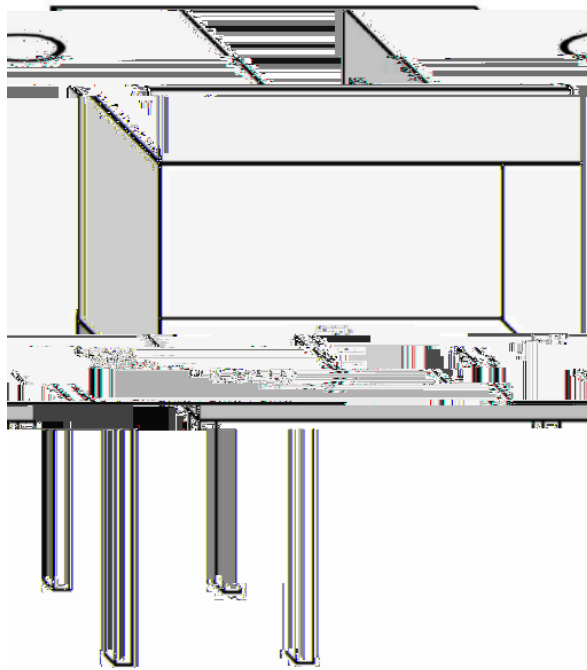

3. Wipe with a dust-free cloth moistened with absolute ethanol.

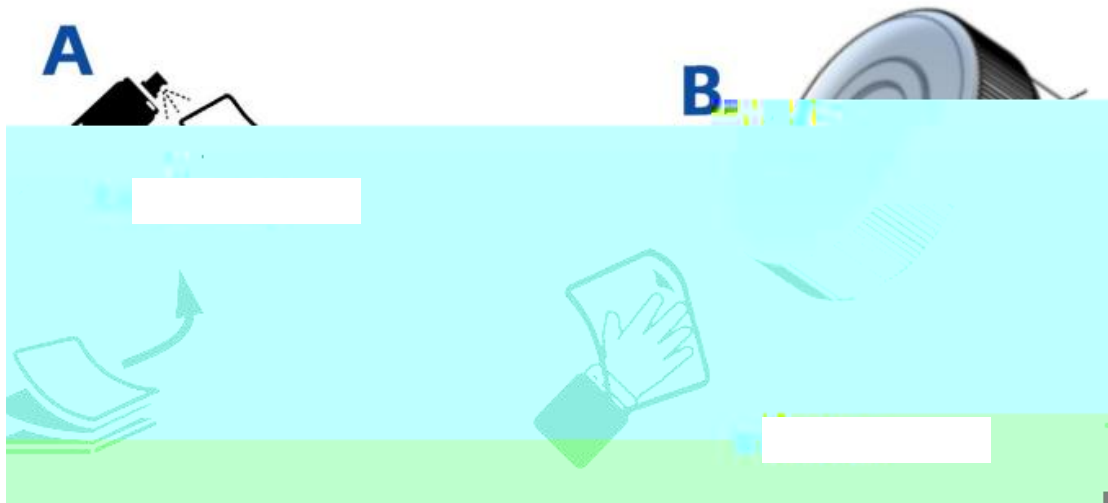

4. Check the cleanliness of the fiber.



Mount the fiber connector onto the microscope Use a clean cotton swab to wipe the cover glass

2.1 QBH Fiber Insertion



WARNING: The optical components must be dust free and all dusts must be cleaned before use. The fiber shall be horizontally inserted into fiber interface to prevent dust from entering the interface and falling on the surface of the lens. Upper limit in the fiber before fixing the laser head.



Rotate QBH locking ring (1) in the direction of the arrow to unlock (Rotate counterclockwise 45°, press down the locking ring, then rotate 45° counterclockwise again.).

Make sure that the fiber is dust free.

Align the red mark of male fiber end to red mark on female QBH of laser head when you insert the fiber end straightly to bottom of QBH interface of laser head.

Turn the QBH handwheel clockwise. It is in place when you hear the "Da" voice, then pull the handwheel up and turn clockwise to end.

2.2 Wrap with Protective Film

To ensure effective sealing, it is recommended to wrap the tape around at least three full turns.



2.3 Mounting of Laser Welding Head

Mount the laser head using 4× M6×16 bolts (1-4) on the machine base or robot back panel. E

2.4 Mounting of Tip Assembly (Optional)

Before installation, confirm that coaxial air-blow assembly, side-blow assembly and wire feeding assembly are complete.

From left to right: F300 coaxial air-blow assembly, air knife assembly, side-blow assembly and wire feeding assembly.

Installation method:

F300 coaxial air-blow assembly

3 Maintenance

3.1 Removal and Installation of Lenses

The whole process needs to be completed in a dust free room. Wear dust-proof gloves or fingertips when removing or installing the lenses.

3.2 Removal and Installation of Top Cover Glass/Protection Glass

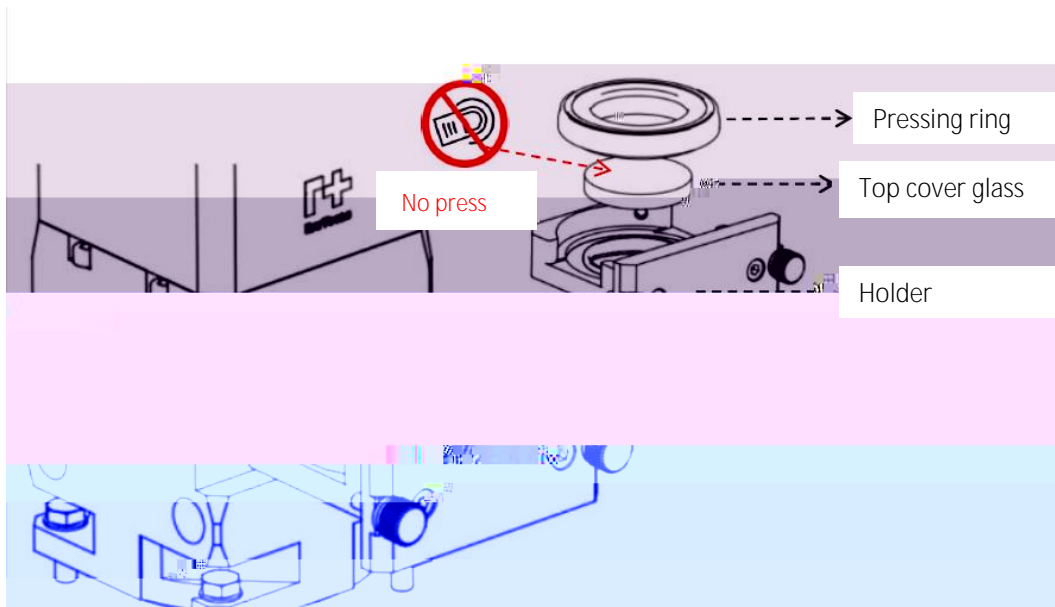

- As shown above, loose the bolts to pull out cover glass holder by pinching 2 edges of drawer type holder.
- Seal the mounting openings by textured tape immediately.
- Remove the pressing ring and cover glass after wearing fingertips
- Clean the cover glass holder.
- Install the cleaned or new cover glass (regardless of the front or back surface) into the holder of cover glass.
- Install the pressing ring.
- Insert the cover glass holder back to the laser head and tighten the bolts.



It is not allowed to pull out the edge of seal ring directly as it is very easy to damage the seal ring. Please wear the clean gloves or fingertips.

3.2.1 removal and Installation of Bottom Cover Glass/Protection Glass

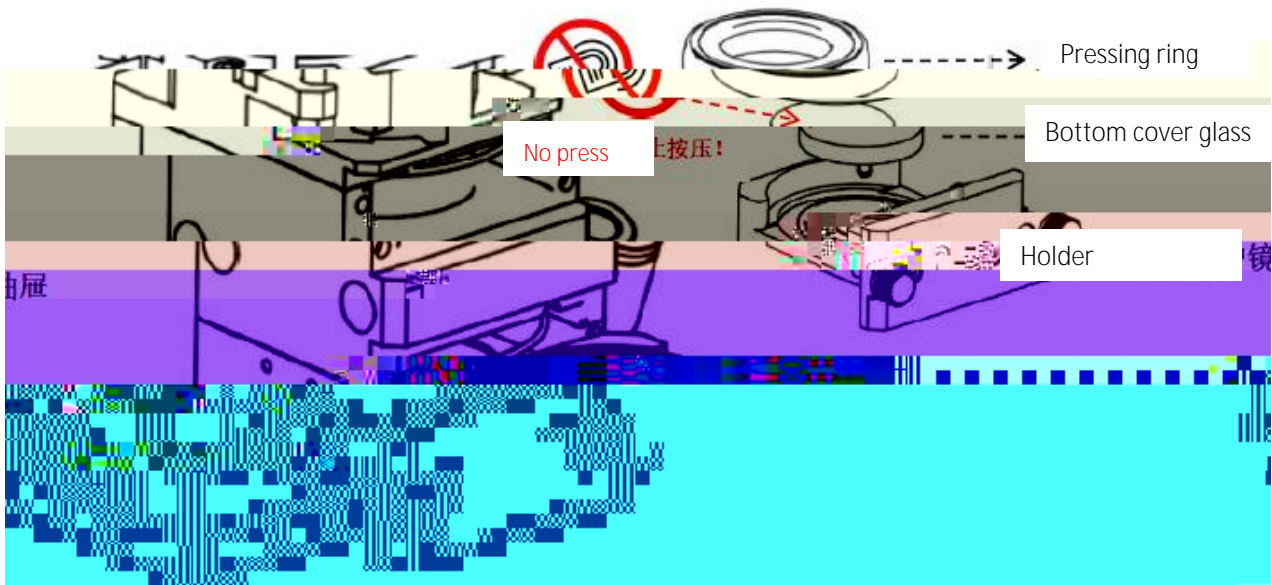

- As shown above, loose the bolts to pull out cover glass holder by pinching 2 edges of drawer type holder.
- Seal the mounting openings by textured tape immediately.
- Remove the pressing ring and cover glass after wearing fingertips
- Clean the cover glass holder.
- Install the cleaned or new cover glass (regardless of the front or back surface) into the holder of cover glass.
- Install the pressing ring.
- Insert the cover glass holder back to the laser head and tighten the bolts.



It is not allowed to pull out the edge of seal ring directly as it is very easy to damage the seal ring. Please wear the clean gloves or fingertips.

4 Appendix

4.1 Mechanical Size

QBH with vision (0°):

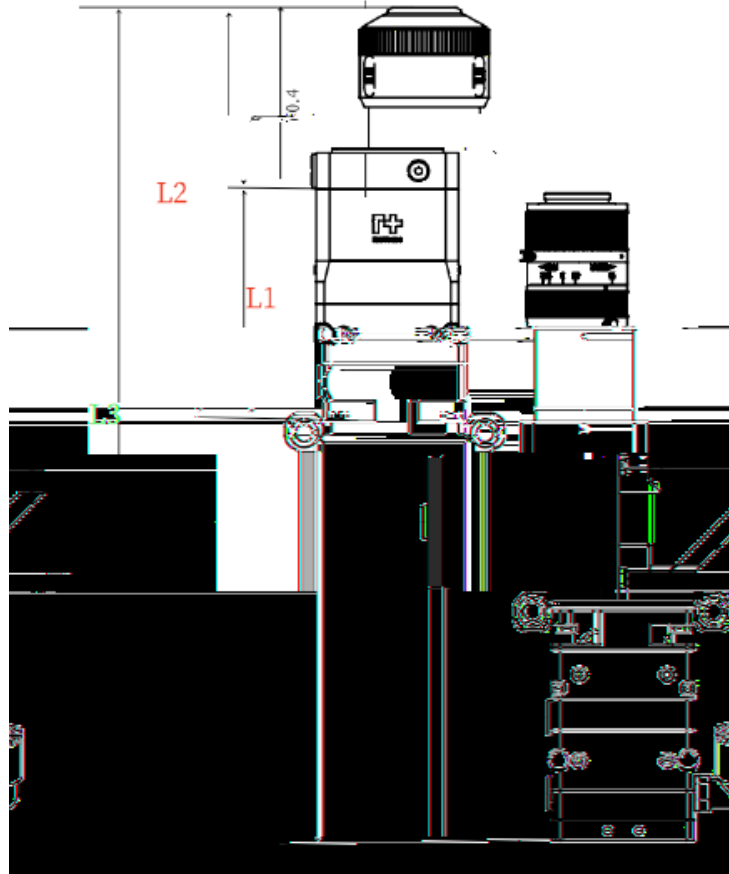

Collimation Length (fC)	L1(mm)	L2(mm)	L3(mm)
F100	94.9	165.3	323.3
F125	119.4	189.8	341.9
F150	145.6	216	374

QBH with vision (90°):

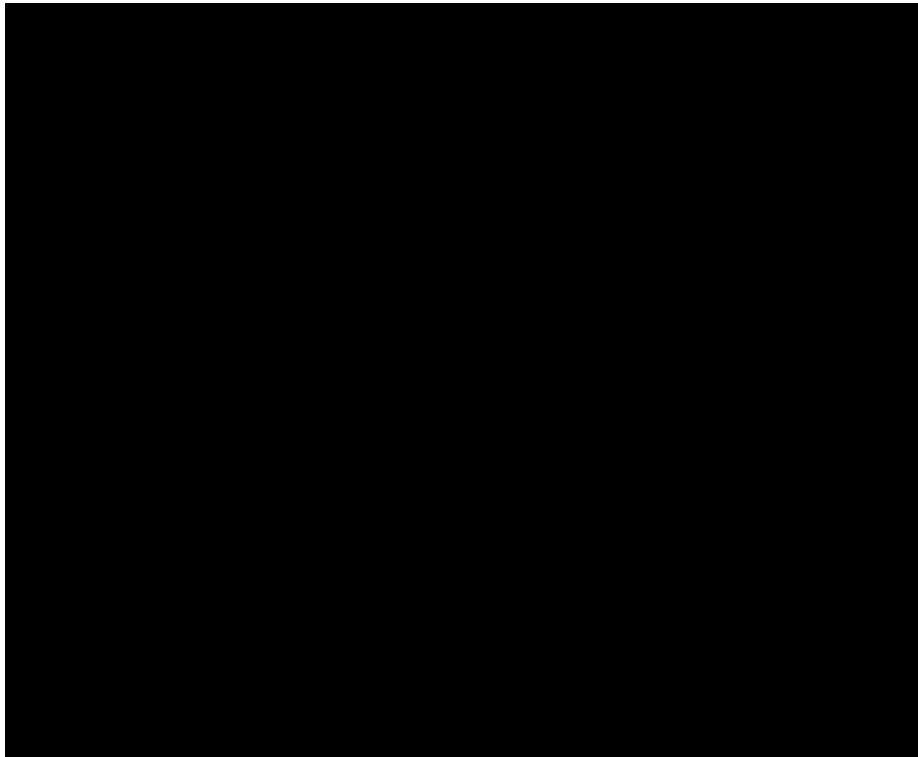

Collimation Length (fC)	L1(mm)	L2(mm)	L3(mm)
F100	94.9	165.3	254.8
F125	119.4	189.8	279.3
F150	145.6	216	305.5

QBH excluding vision (0°):

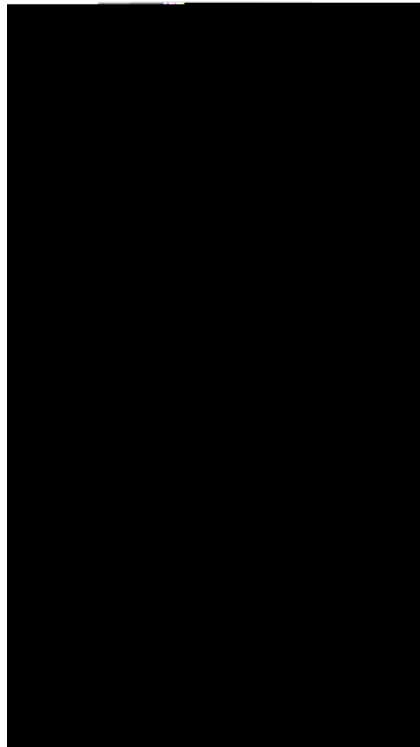

Collimation Length (fC)	L1(mm)	L2(mm)	L3(mm)
F100	94.9	165.3	323.3
F125	119.4	189.8	341.9
F150	145.6	216	374

OBH excluding vision (90°):

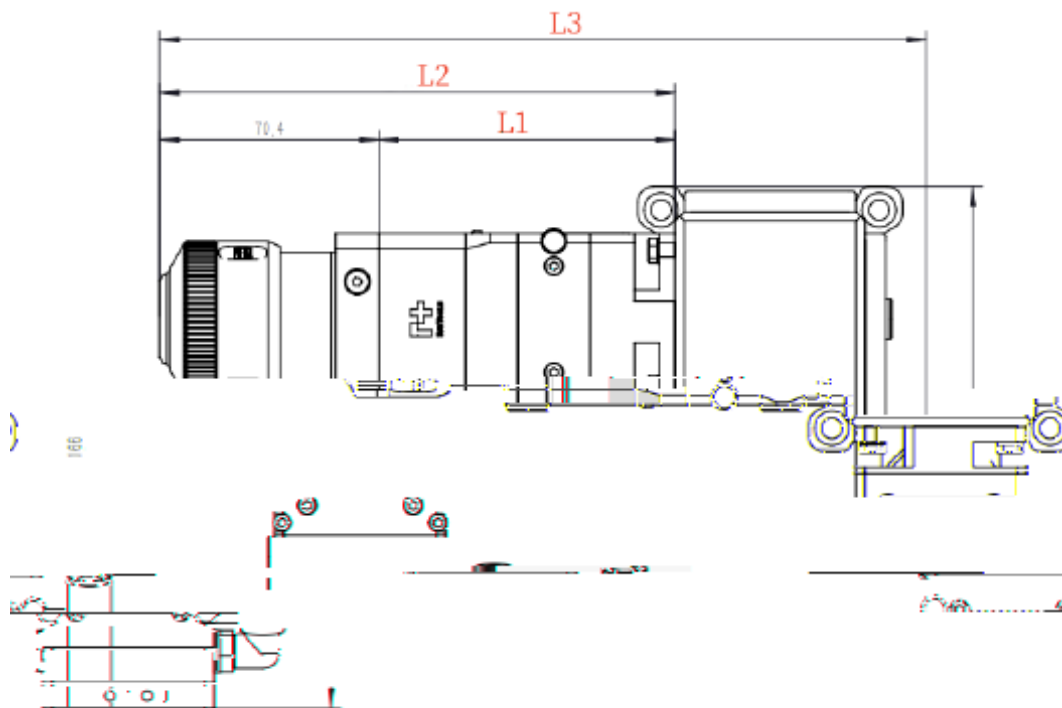

Collimation Length (fC)	L1(mm)	L2(mm)	L3(mm)
F100	94.9	165.3	254.8
F125	119.4	189.8	279.3
F150	145.6	216	305.5